

# Efficient Micro-Mobility using Intra-domain Multicast-based Mechanisms (M&M)

Ahmed Helmy  
Electrical Engineering  
Department

University of Southern California  
helmy@usc.edu

Muhammad Jaseemuddin  
Electrical and Computer  
Engineering

Ryerson University  
jaseem@ee.ryerson.ca

Ganesh Bhaskara  
Electrical Engineering  
Department

University of Southern California  
bhaskara@usc.edu

## Abstract

One very important metric in evaluation of IP mobility protocols is handover performance. Handover occurs when a mobile node changes its network point-of-attachment. If not performed efficiently, handover delays, jitters and packet loss directly impact applications and services. With the Internet growth and heterogeneity, it becomes crucial to design efficient handover protocols that are scalable, robust and incrementally deployable. Mobile IP (MIP) has been shown to exhibit poor handover performance during micro-mobility. We propose a new architecture for providing efficient and smooth handover, while being able to co-exist and inter-operate with other technologies. Specifically, we propose an intra-domain multicast-based mobility architecture, where a visiting mobile is assigned a multicast address to use while moving within a domain. Efficient handover is achieved using standard multicast join/prune mechanisms.

Two approaches are proposed and contrasted. The first introduces the concept of proxy-based mobility, while the other uses algorithmic mapping to obtain the multicast address of visiting mobiles. We show that the algorithmic mapping approach has several advantages over the proxy approach, and provide mechanisms to support it.

Simulations used to evaluate our scheme and compare it to other micro-mobility schemes - CIP and HAWAII. The proactive handover results show that both M&M and CIP show low handoff delay and packet reordering depth as compared to HAWAII. The reason for M&M's comparable performance with CIP is that both use bi-cast in proactive handover. M&M, however, handles multiple border routers in a domain, where CIP fails. Also using a proactive path setup mechanism, we show that M&M clearly outperforms CIP in case of reactive handover.

## 1. Introduction

The growth of mobile communications necessitates efficient support for IP mobility. IP mobility addresses the problem of changing the network point-of-attachment transparently during movement. When the mobile node moves away from its current network point-of-attachment, *handover* is invoked to choose another suitable point-of-attachment. In such an environment, handover latency and mobility dynamics pose a challenge for provisioning of efficient handover.

Several studies [1][8] show that Mobile IP [3], the proposed standard, has several drawbacks ranging from triangle routing and its effect on network overhead and end-

to-end delays, to poor performance during handover due to communication overhead with the home agent. Several micro-mobility approaches attempt to modify some mechanisms in Mobile IP (MIP) to improve its performance [4][5]. However, as we will show, such approaches suffer from added complexity and, in general, do not achieve the best handover performance.

We follow a different approach to IP mobility using multicast-based mobility (*M&M*) [1]. In such paradigm, each mobile node is assigned a multicast address to which it joins through the access routers it visits during its movement. Handover is performed through standard IP-multicast join/prune mechanisms. Such approach, however, is not suitable for inter-domain IP mobility, for several reasons. First, the architecture requires ubiquitous multicast deployment, which is only partially supported in today's Internet. M&M should be designed for incremental deployment, and to allow co-existence with other IP mobility protocols. Second, the multicast state kept in the routers grows as the number of mobile nodes becomes larger. This problem may be alleviated using state aggregation [38]. Third, allocating a globally unique multicast address for every mobile node requires a global multicast address allocation scheme, and wastes multicast resources. Furthermore, mobile nodes incur security delay with every handover, which may overshadow architectural mechanisms that attempt to reduce handover delays.

To alleviate these problems, we propose new schemes for *intra-domain* multicast-based micro-mobility that allow for incremental deployment. In this architecture, a mobile node is assigned a multicast address within a domain for use with *micro* mobility. The allocated multicast address is locally scoped (i.e., unique only domain-wide). This allows for domain-wide address allocation schemes. Packets are multicast-tunneled to the mobile node within the domain. The multicast address of a mobile does not change throughout its movement within the domain. This allows for lighter-weight security during handover, as it is used for micro-mobility (i.e., intra-domain).

In this paper we present two different approaches to multicast-based micro mobility, one approach is based on *mobility proxies* and the other based on a novel scheme for *algorithmic mapping*. We compare such approaches and

show that algorithmic mapping provides a more scalable and robust approach, and we develop efficient, yet simple, mechanisms to realize it. Furthermore, we conduct extensive simulations to compare the handover performance of our approach to other routing-based micro-mobility schemes. The proactive handover performance results show that our scheme performs as well as CIP and much better than HAWAII. Furthermore, it handles multiple border routers in a domain where CIP fails. For reactive handover M&M has a clear edge over CIP.

The paper is outlined as follows. Section II introduces multicast-based mobility. Section III gives overview of the intra-domain architecture, and discusses the proxy-based approach. Section IV describes the algorithmic mapping approach in detail. Section V gives evaluation and comparison results. Section VI discusses related work. Section VII concludes.

## 2. Multicast-based Mobility (M&M)

Performance during handover is a significant factor in evaluating performance of wireless networks. IP-multicast [25][2] provides efficient location independent packet delivery. The receiver-initiated approach for IP-multicast enables receivers to join to a nearby branch of an already established multicast tree. Multicast-based mobility (M&M) [1][8] uses this concept to reduce latency and packet loss during handover.

In multicast-based mobility, each mobile node (MN) is assigned a multicast address. The MN, throughout its movement, joins this multicast address through locations it visits. Correspondent nodes (CN) wishing to send to the MN send their packets to its *multicast* address, instead of unicast. Because the movement will be to a geographical vicinity, it is highly likely that the join from the new location, to which the mobile recently moved, will traverse a small number of hops to reach the already-established multicast distribution tree. Hence, performance during handover improves considerably. An overview of this architecture is given in Figure 1. As the MN moves, it joins to the assigned multicast address through the new access router (AR). Once the MN starts receiving packets through the new location, it sends a prune message to the old AR to stop the flow of the packets down that path. Thus completing the smooth handover process. In spite of its promise, we believe that many issues need to be addressed to realize multicast-based mobility in today's Internet. These issues include scalability, multicast address allocation, multicast deployment and security.

*Scalability of Multicast State:* The state created in the routers en-route from the MN to the CN is source-group ( $S, G$ ) state. With the growth in number of mobile nodes, and subsequently, number of groups ( $G$ ), the number of states kept in the routers increases. In general, if there are ' $x$ ' MNs, each communicating with ' $y$ ' CNs on average, with an

average path length of ' $l$ ' hops, then number of states kept in the routers is ' $x*y*l$ ' states. Clearly, this does not scale.

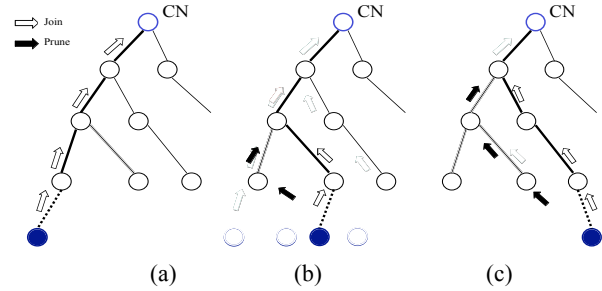

**Figure 1: Multicast-based mobility. As the MN moves, as in (b) and (c), the MN joins the distribution tree through the new location and prunes through the old location.**

*Multicast Address Allocation:* Inter-domain M&M requires each MN to be assigned a globally unique multicast address. Using a global multicast address for each MN may be wasteful and requiring uniqueness may not be practical.

*Ubiquitous Multicast Deployment:* Inter-domain M&M assumes the existence of inter-domain multicast routing. We believe, however, that incremental deployment and interoperability should be an integral part of any architecture for IP mobility.

*Security Overhead:* Security is critical for mobility support, where continuous movement of mobiles is part of the normal operation. Such setting is prone to remote redirection attacks, where a malicious node redirects to itself packets that were originally destined to the mobile. The problem is even more complex with multicast, where any node may join the multicast address as per the IP-multicast host model. These security measures are complex and may incur a lot of overhead. If such measures are invoked with every handover, however, it may overshadow the benefits of efficient handover mechanisms<sup>2</sup>.

To address the above issues, we propose a new approach for intra-domain multicast-based mobility.

## 3. Intra-domain Architectural Overview

In our intra-domain architecture, a mobile node is assigned a multicast address to which it joins while moving. The multicast address, however, is assigned only within a domain and is used for *micro* mobility. While moving between domains, an inter-domain mobility (e.g., Mobile IP) protocol is invoked. In Mobile IP (MIP) [3], every mobile

<sup>1</sup> Multicast address allocation is an active area of research [15]. We envision the number of MNs to grow tremendously.

<sup>2</sup> Providing a comprehensive security solution for IP mobility is beyond the scope of this work. We believe, however, that our schemes relaxes security requirements during handover.

node (MN) is assigned a home address and home agent (HA) in its home subnet. When the MN moves to a foreign subnet, it acquires a care-of-address (COA) through a foreign agent (FA). The MN informs the HA of its COA through a registration process. Packets destined to the MN's home address are intercepted by the HA in the home subnet, then it tunnels them to the MN's COA. This is known as triangle routing. We will use the Mobile IP model to discuss inter-domain routing in the following sections.

Several mechanistic building blocks are needed to realize our proposed architecture. First, when the mobile moves into a new domain it is assigned a multicast address. What is the address allocation scheme? Second, packets destined to the mobile are multicast-tunneled by an encapsulator to the mobile node. How are the encapsulator(s) selected and where are they placed? To answer these questions, we investigate two different approaches: (1) *Proxy-based architecture*, and (2) *Algorithmic mapping architecture*.

### 3.1 Reference Architecture

We consider an IP network for a single domain, as shown in Figure 2. The network is connected to the Internet through Border Routers (BRs). An Access Point (AP) is the radio point of contact for a mobile node. A number of APs are connected to an Access Router (AR). From the access router's point of view, each AP is a node on a separate subnet. When a mobile moves from one AP to another without changing AR is an intra-AR handover case that can be specific to AR implementation and is not considered in this paper.

When a mobile moves into a new domain it is assigned a multicast care of address (MCOA). It is also assigned a unicast address that is unique within the domain, called regional care of address (RCOA). Since MCOA is used for routing packets within the domain, there is no need to assign COA at every subnet. The RCOA is a unique unicast address on the *m-subnet*. The *m-subnet* is a unique subnet that is characterized by the mobility where mobile nodes can use their RCOA to establish communication through any AR at the edge of the network. Hence, the *m-subnet* can be viewed as a logical subnet formed by all APs at the edge of the network. All ARs include the prefix for *m-subnet* in their router advertisements [37].

Address allocation and management is discussed later in this paper. When a mobile moves from one AR to another, it is said to handover from old AR ( $AR_{old}$ ) to new AR ( $AR_{new}$ ). We use this terminology throughout the rest of the paper.

First, we shall describe the proxy-based approach and discuss the problems associated with it.

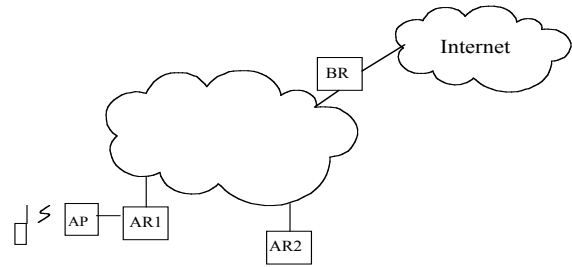

Figure 2: Reference mobility domain network

### 3.2 Proxy-based Architecture

When a mobile node moves into a new domain, it contacts its access router (AR). The AR performs the necessary per-domain authentication and security measures, and then assigns RCOA for the mobile node (MN). As shown in Figure 3, the AR then sends a *request* message to the mobility proxy (MP) to obtain a multicast address for the visiting MN. The request message includes the home address of the mobile node and its home agent's address. Upon receiving the request the MP performs two tasks. The first is to register on behalf of the mobile node its own address as COA with the MN's home agent. The second task is to assign a multicast address for the visiting MN, send a *reply* message to the AR and keep record of this mapping. The mapping is used for packet encapsulation later on. In this scheme, the MP remains transparent to the MN, which makes the placement of MPs within the domain flexible without notifying every MN.

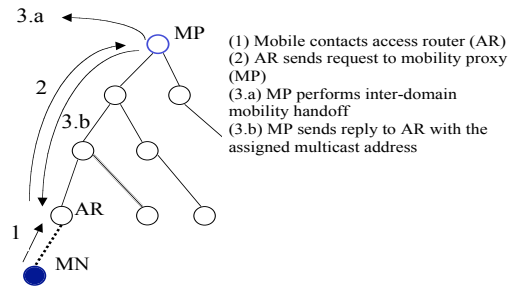

Figure 3: Event sequence as the mobile node moves into a domain

Once this step is complete, the visiting MN joins the assigned multicast address ( $G$ ). The joins are sent to the proxy-group pair ( $MP, G$ ) and are processed as per the underlying multicast routing. The MN continues to move within the domain using the same multicast address. The scope of the assigned multicast address is local to the domain. Handover is performed using standard join/prune mechanisms and only lightweight intra-domain security is required in this case.

Packets sent to the MN's home address are tunneled by the HA to the MP using inter-domain mobility. The packets

are then encapsulated by the MP, based on the recorded mapping, and sent down the multicast tree to the MN. The MN uses the unicast RCOA for sending packets. To avoid single-point-of-failure scenarios multiple MPs are used. These MPs are typically placed at the border of the domain or at the center of the network<sup>3</sup>. An algorithm similar to [24] may be used for dynamic MP liveness and election mechanisms.

Several issues need to be addressed in the above architecture. First, the MPs need to maintain unicast-to-multicast address mapping for all visiting MNs. The scalability of such a scheme is of question. Second, complex robustness algorithms are needed to maintain MP liveness information, requiring initial configuration and setup. Third, the service disruption effect of MP failure is not clear. Since the MP registers its own address with the home agent and is used to encapsulate incoming packets, this introduces a third-party-dependence problem that is undesirable. In addition, MPs should run a multicast address allocation scheme to ensure collision-free address assignment.

To address these problems we propose a novel approach based on *algorithmic mapping* that obviates the need for explicit unicast-to-multicast mapping, and eliminates the need for complex address allocation.

#### 4. Algorithmic Mapping Architecture

This section provides detailed address management, duplicate address detection, and inter-AR handover.

##### 4.1 Overview

In this scheme we assume there is a one-to-one mapping between an RCOA and MCOA. When a mobile moves into a new domain it is assigned RCOA by the AR and the mobile performs inter-domain handover i.e., it registers the RCOA with its home agent. The AR automatically infers the multicast address (MCOA) for the mobile node from the assigned unicast address (RCOA) through a straight forward *algorithmic mapping*, described later in this section. The AR then triggers a Join message for MCOA to establish the multicast tree. Packets destined to the MN's home address are tunneled to its RCOA by the HA. When these packets arrive in the foreign domain they are identified by the border router (BR) as being destined to a node on the m-subnet. As shown in Figure 4, the BR maps the destination unicast address to the multicast address and transmits the packets to the MN down the multicast tree. The serving AR changes the destination address from multicast to the unicast address. Since the destination address is modified twice within the network and restored to the RCOA by the AR, the packet does not cause security association violation at the mobile node.

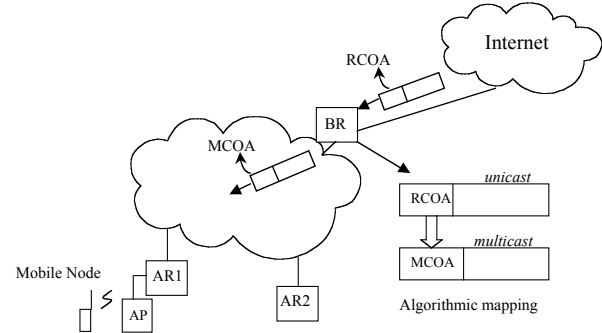

**Figure 4: Architectural view: A packet is unicast to the RCOA and arrives at the border router (BR) for the mobile node. The BR intercepts the packet and performs algorithmic mapping from the RCOA to MCOA. The packet is then multicast within the domain.**

This architecture provides several advantages over the proxy-based approach. It avoids the third party dependence on the MP. Moreover, since algorithmic mapping is used, no explicit RCOA-MCOA mapping is kept or maintained by the encapsulator, which solves the mapping scalability problem and provides a more robust mechanism.

#### 4.2 Address Management

The number of multicast addresses required is proportional to the number of mobile nodes in the domain. The scope of an MCOA is local to the domain where it is used. The IPv6 multicast addressing provides facility to define scope within the address [32]. Hence, in the rest of the paper we consider IPv6 address for both RCOA and MCOA.

FP	TLA ID	Rsvd	NLA	SLA	Interface ID
----	--------	------	-----	-----	--------------

(a) IPv6 unicast address

11111111	Flags	Scope	Group ID
----------	-------	-------	----------

(b) IPv6 multicast address

FP	TLA ID	Rsvd	NLA	SLA	Interface ID
↓		↓		↓	
11111111	0000	0110	Reserved	Interface ID	

(c) RCOA to MCOA mapping

**Figure 5: Algorithmic mapping**

The standard IPv6 unicast and multicast address architectures [32] are shown in Figure 5 (a) and (b). We modify the group bits to include interface ID as the group ID. The remaining reserved bits of the group ID are ignored by multicast routing. The 64-bit interface ID address space is large enough for all the mobiles within a domain. We also

<sup>3</sup> Network center are nodes with min(max distance) to any other node [26].

define a new scope: micro-mobility scope with value 0x6. The SLA is a 16-bit long field, used to create local hierarchy and identify subnets [33]. A single subnet ID, identifying m-subnet, is defined for assigning RCOA.

When a mobile moves into a foreign domain it is assigned an RCOA. The AR forms the MCOA by replacing the <FP, TLA ID> bits of the RCOA with the multicast <FP, flag (0000), scope (0110)> values. This provides a simple, yet very efficient and unique *algorithmic mapping*. The mobile acquires RCOA on the m-subnet through either DHCP [34] or autoconfiguration. The auto-configuration requires duplicate address detection (DAD) [35] on every subnet. In our scheme the mobile obtains RCOA and MCOA once it is connected to the network. We propose a scheme in [39] that detects address duplication within the m-subnet, which is performed once at the AR during initial address assignment. The mobile afterward is able to move freely without running DAD at any other AR. In any case, when a mobile first connects to the network it must perform a high latency inter-domain handover, hence duplicate address resolution latency is overshadowed by this handover latency.

### 4.3 Intra-domain Handover

When a mobile moves from one AR to another, a handover event takes place between the two routers. The handover involves route repair that is path setup inside the network to redirect the incoming traffic flow to the new AR. In proactive handover the link between the MN and new AR is established prior to its disconnection with the old AR. Hence a smooth handover, i.e. handover with low packet loss, can take place by exploiting the fact that the new AR is known a priori and bi-casting packets to both access routers is possible. In reactive handover an abrupt disconnection may cause the MN to switch over to the new AR. The route repair in this case can only be initiated from the new AR, hence bi-casting cannot reduce packet loss. Multicasting allows proactive path setup to the new access router before the mobile is actually connected to it. This can minimize packet losses in reactive handover where bi-casting fails. Moreover, bi-casting being a special case of multicasting, multicasting-based solution, e.g. M&M, performs equally well for achieving proactive handover. In this section we describe one handover scheme where proactive path setup is used to achieve smooth reactive handover.

We define a set of adjacent access routers as the Coverage Access Router Set (CAR-set). The adjacency can be established based on the adjacency of the radio coverage area of the serving AR in case of cellular wireless network. The serving AR is called the Head of the CAR-set. Thus, there is a unique CAR-set defined for every AR. For example, in Figure 6 AR1 to AR7 constitute a CAR-set for AR1, which is the serving AR for the mobile. The mobile can move to any of the ARs in the CAR-set without interruption in the packet flow. The idea of CAR-set is similar to Handoff-Affected Router Group (HARG) proposed in [41].

The HARG is a group of routers in the network that are affected by the handoff when a mobile node moves from one access point to another and need to do route repair. The fundamental difference with HARG is that the CAR-set is a set of access routers that are selected to receive the packets destined to the mobile node.

A site-local multicast group address is assigned to each CAR-set, called CAR-set group address (CGA). Every AR that is a member of a CAR-set must join the corresponding CGA, which serves as a control channel for the members to exchange the control signals. For example, in Figure 6, all the access routers surrounding AR1 join CGA1 to become members of AR1's CAR-set (CGA1). Similarly, AR1 must also join six other CAR-sets corresponding to adjacent routers AR2 to AR7.

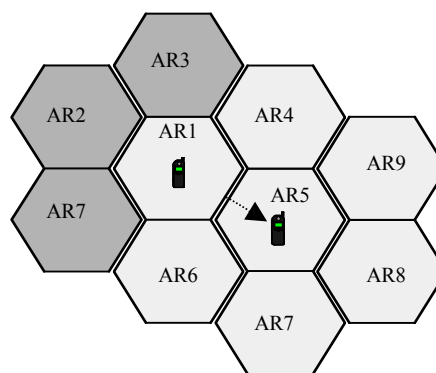

Figure 6: Handover across CARs

We define three new control signals as follows:

1. *J-message* causes the receiving router to *join* the multicast group identified in the message.
2. *L-message* causes the receiving router to *leave* the multicast group identified in the message.
3. *HO* message exchanged between the two routers involved in handover. Its parameters include the mobile's RCOA and MCOA.

We explain the handover algorithm by using the example depicted in Figure 6. Consider the MN moving from AR1 to AR5. When connectivity is established between the MN and AR5, the AR5 multicasts a J-message <MCOA> to the members of its CAR-set (CGA5) requesting them to join the mobile's MCOA. It then sends HO <RCOA, MCOA> message to AR1 to initiate the prune process. When AR1 receives HO message it multicasts an L-message <MCOA> to members of its CAR-set (CGA1) requesting them to leave the MCOA.

Although the ordering of (J => HO => L) messages ensures that L-message is initiated after J. The order of message reception, however, is not guaranteed to both CAR-sets. Depending on the order of arrival of J and L messages at an AR that is a member of both CAR-sets, it may leave the MCOA whereas it is supposed to have remained joined to

that group. To ensure consistency between Join and Leave messages we introduce the following mechanism. Each AR keeps its membership status in a 4-tuple <MCOA, Serving Access Router (SR), CGA, State> table. The table contains an entry corresponding to every mobile roaming in a CAR-set of which the access router is a member. There are two states defined: Joined and Left. The rules for updating the table specify that an AR only accept L-message for a MCOA, if the source of the L-message matches the SR in the MCOA's entry (i.e., the AR has joined the MCOA on the request of the same SR)<sup>4</sup>. Otherwise, the L-message is discarded. The AR accepts all J-messages and creates/updates the related MCOA entry to include the source of the J-message (as the SR), CGA to the SR's CGA (as the entry's CGA), and the state to Joined.

Consider the example shown in Figure 6. Assume that the mobile's MCOA is MG and after power up in the domain it connects to AR1, which then multicasts a J-message to its CAR-set (CGA1). When AR4 receives the J-message, it joins MG and creates an entry corresponding to the MCOA in Joined state as shown in Figure 7 (a). Later when the MN moves to AR5 it becomes the new serving router. Then AR5 sends a multicast J-message to its CAR-set (CGA5) followed by a HO message to the old serving router AR1. Since AR4 is a member of both CGA1 and CGA5, it receives both J-message from AR5 and L-message from AR1. After receiving the J-message the table entry is updated as shown in Figure 7 (b). If received after the J-message, the L-message is discarded. Thus, AR4 remains joined to MG. If received before the J-message, however, the L-message may cause AR4 to leave the MG, which interrupts packet flow to AR4 until it receives the J-message and joins the MG group. The interruption may be minimized by delaying the leave operation. In most cases the HO message delay is sufficient to minimize the interruption. A simple scheme can be employed that periodically checks the table to purge all the entries that are in the Left state and consequently prune the corresponding multicast trees.

MCOA	Serving Router	CGA	State
MG	AR1	CGA1	Joined

(a)

MCOA	Serving Router	CGA	State
MG	AR5	CGA5	Joined

(b)

**Figure 7: Table state at AR4 (a) when MN1 is connected to AR1, (b) after MN1 moved to AR5**

<sup>4</sup> To account for lost L-message, or crash of the SR, a soft-state mechanism is used. SR sends periodic J-messages containing table changes (if any) and providing liveness.

## 5. Evaluation and Comparison

In order to evaluate the performance of M&M and compare it to other known schemes, and conducted detailed simulations for CIP [20], Hawaii [21] and M&M – the three routing-based mobility solutions<sup>5</sup>. We modified the network simulator, ns-2 [17] to incorporate M&M. We changed the implementation of mobile node and access router to add mobility detection, handover algorithm and multicast routing.

### 5.1 Performance Metrics

We used the following performance metrics to evaluate the performance of M&M and compare it to CIP and HAWAII.

- *Handoff delay* is defined as the difference between the time at which the MN received the last packet from the old access router and the first packet from the new access router.
- *Depth of packet reordering* is measured as the maximum difference in the sequence numbers of adjacent packets. This is a rough indicator of the size of the buffer needed to re-sequence the out of order packets.
- *Packet duplication* is the total number of packets duplicated in a single handoff. This is measured as the duration for which reordering occurs. Since CBR traffic is used, reordering duration gives an estimate of how many packets can be duplicated irrespective of the packet rate at the source.
- *Routing efficiency* is defined as the ratio of the number of hops between the root of the tree and the MN to the number of hops on the shortest path between the two. This gives a qualitative comparison of routing efficiency.

Mobility detection need not necessarily be a part of the micro-mobility protocol as this can be better achieved with additional information from lower layers.

### 5.2 Simulation Scenarios

To study the factors affecting the performance of the micro-mobility protocols we simulated a rich set of scenarios including tree topologies of varying depth ranging from 3 to 6. The link bandwidths were fixed at 10Mbps for wired links with delays varied from 10ms to 5ms to 2ms for all links. Detailed 802.11 models in ns-2 were used for the wireless part with cell overlap of 30m. Beacons spacing 200ms apart are used for mobility detection. State timeout of 1s (as lower

<sup>5</sup> We have also compared our scheme to hierarchical MIP [27] and seamless handoff [31] schemes using route-based analysis. Please refer to [39] for details. As was shown in [39] M&M achieved the min handoff delay and min overhead among the three classes.

bound) is set for the multicast protocol. We have used CIMS extensions of ns-2 that implement CIP and HAWAII<sup>6</sup>. In addition, we developed our own extensions of ns-2 to support M&M. The handoff mechanism for M&M, CIP and HAWAII are bi-cast, semi-soft handoff and Multi Stream Forwarding (MSF) [21], respectively. Both M&M and CIP use bi-cast technique whereby packets are bi-cast to both old and new ARs from a crossover point within the network. In contrast, HAWAII uses buffer and forward technique where the old AR buffers the packets and forwards them during route repair. Random mobility at 30m/s was the mobility pattern used for the MN. CBR traffic with packet size of 512 bytes and 10ms/packet was used. To avoid the side effects of mechanisms of other protocols (like congestion control mechanism of TCP) affecting the handoff delay and packet delivery performance, we chose CBR over UDP as opposed to FTP over TCP.

### 5.3 Simulation Results

We conducted simulations over different topologies, varying parameters like beacon timer, and link delays. Since mobility detection mechanism is not a part of the protocol, simulations were set-up such that mobility detection always succeeded when the MN moved from one access router to another. This was to prevent loss of packets due to failure of the underlying mobility detection scheme.

Graphs for different topologies show the similar trends; hence we select simple graphs for the tree topology with depth 3. Figure 8 shows the topology used in the simulation.

All the graphs follow a common format. Each graph shows data for M&M, CIP and HAWAII (in that order from left to right). The x-axis shows three sets of data corresponding to link delays of 10ms, 5ms and 2ms (again from left to right) for each protocol. Path lengths from the fork (crossover) router to old and new access routers vary along y-axis. For example, '3,2' means path length of 3 hops from the fork router to the old access routers and 2 hops from the fork router to the new access router. The z-axis shows the performance parameters under evaluation.

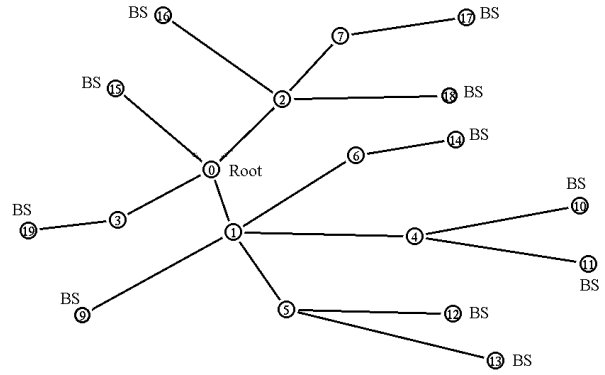

Figure 8: Simple tree topology

Figure 9 illustrates the handoff delays incurred by M&M, CIP and HAWAII with link delays 10, 5 and 2ms. From the graphs, we observe that the handoff delay for M&M and CIP is small as compared to that of HAWAII. Both CIP and M&M use bi-cast, which causes smooth handover with negligible handover delay. Whereas, HAWAII using the MSF, a buffer and forward scheme that consistently incurs long handoff delays.

Figure 10 shows the depth of reordered packets. We measured depth of reordering instead of the number of packets reordered because it indicates the size of buffer needed to re-sequence the out of order packets. It is obvious from the graph that the depth of reordering is small for M&M and CIP, whereas it is large for HAWAII. The out of sequence packets in M&M and CIP are dependent on the difference in the link delays from fork router to old and new access routers. The greater the difference, the greater will be the depth of reordering. In case of HAWAII the depth is large because the old access router buffers packets and then forwards it to the new access router via the crossover router. The crossover router also forwards the incoming packets to the new access router at the same time. This results in packets reaching the new AR out of order. Depth of reordering is dependent on the buffering duration and the link delays from the cross over router to the old AR. It is important to observe the duration for which reordering of packets occur. In M&M and CIP, reordering occurs as long as bi-casting is done. However, in HAWAII, reordering duration depends on the number of packets buffered at the old AR and the link delay from the old AR to the crossover point.

<sup>6</sup> We used the CIMS (Columbia IP Micro-mobility Suite) at <http://comet.ctr.columbia.edu/micromobility/software.htm>

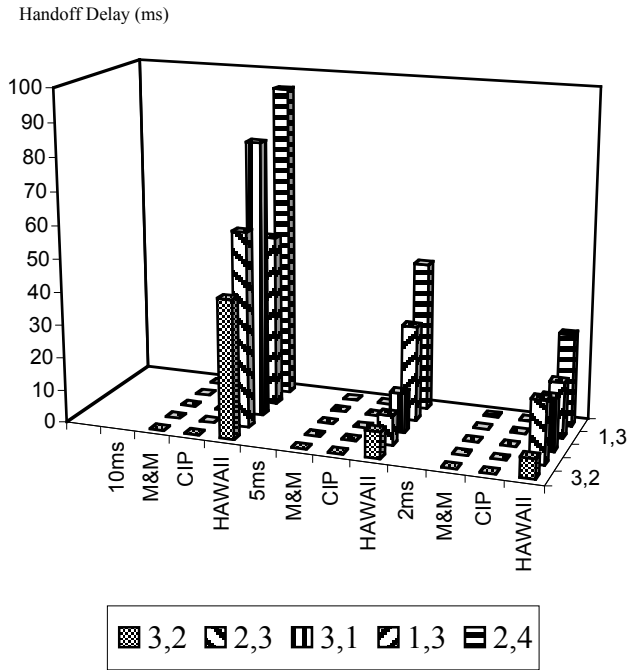

Figure 9: Handoff delay

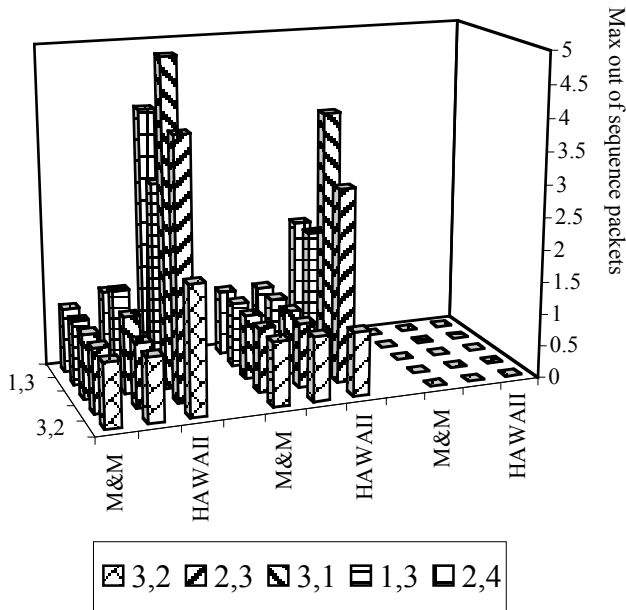

Figure 10: Maximum difference in sequence numbers of consecutive packets

The duration for which reordering of packets occurs indicates an estimate of the amount of packet duplication caused by a scheme. Figure 11 shows the reordering duration incurred by the three schemes. As previously mentioned, in case of M&M and CIP, the reordering occurs as long as bi-

casting lasts causing large number of packet duplication as shown in the figure. Whereas, for HAWAII reordering duration depends on the number of packets buffered at the old access router and the link delay from the old access router to the crossover point, which shows relatively low number of duplications.

M&M uses the multicast path to route packets to the MN. In many cases the border router (BR) acts as the root (RP) of the multicast tree. CIP uses the shortest path along the reverse path from the MN to the BR to route packets from the BR to the MN. In most cases the routing in M&M is as efficient as CIP. In case of HAWAII routing is a function of topology and node mobility, which is generally less efficient than that of M&M and CIP.

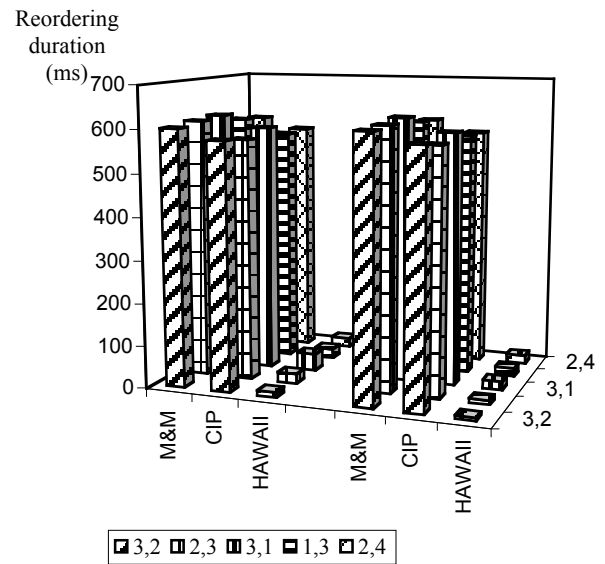

Figure 11: Reordering duration

Both HAWAII and CIP do not handle well the case where a domain contains multiple border routers. In particular, if packets enter the domain through one border router and leave through another border router, routing in CIP fails. M&M relies on the underlying multicast protocol to handle multiple border routers in a domain, which is often the case. For example, mechanisms exist in PIM-SM to deliver packets to the RP irrespective of the location of the sender (BR at which the packet enters the domain). The flexibility comes at the expense of possible reduction of routing efficiency, because packets are first tunneled to the RP and then delivered to the MN through the multicast tree. To alleviate this situation the BRs may be configured as candidate RP for the MCOA prefix, thus ensuring that one of the BRs becomes the RP.

## 5.4 Re-active Handover

M&M has a clear edge over any other unicast based micro-mobility protocol (e.g., Cellular IP and Hawaii) during reactive handover. Reactive handover occurs when a mobile node moves out of coverage, due to obstacles, lack of cell overlap, etc., then re-enters the coverage of a new cell. Some wireless technologies, e.g. IEEE 802.11, only support reactive handover. In such scenarios (that are not uncommon), bi-casting (i.e., getting packets from both the old and new base stations) as used in CIP, is not possible. For bi-casting to occur the mobile needs to be connected to both base stations simultaneously. Prediction may be used to sent packets to potential future base stations, but bi-casting can only send to one new base station (extending bi-casting to send packets to multiple base stations is basically re-inventing multicasting). M&M, on the other hand, by virtue of being a multicast protocol, is able to send to multiple (2 or more) base stations. The CAR-set protocol presented in this paper pro-actively sends packets to all potential future base stations thus reducing delays and packet losses during reactive handover drastically. Figure 12 shows the number of packet losses incurred during reactive handover. Two scenarios were used, the first has 0m overlap between cells, and the second has 10m gap between cells. Hawaii and M&M incur very little or no packet loss, whereas CIP incurs significant packet loss. Hawaii's reduced packet loss is due to the buffering of packets (which comes at the expense of extended handover delays). Handover delay (from the point when the mobile node detects the new access router) is similar to that given in **Figure 9** above. It is quite clear that M&M has the best performance in terms of both packet loss (clearly outperforming CIP) and handover delays (clearly outperforming Hawaii) during reactive handover.

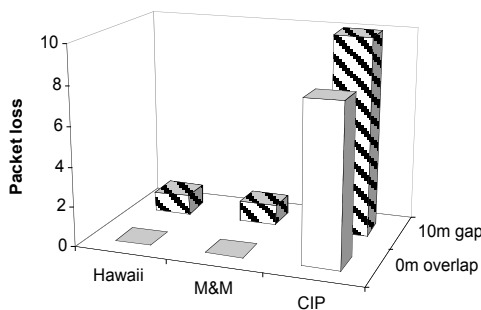

Figure 12: Packet loss for reactive handover

## 5.5 CAR-set Multicast Overhead

Multicasting packets to the CAR-set causes overhead of packet replication over links leading to the access routers that belong to the CAR-set. The extent of overhead depends upon

the network topology and the size of the CAR-set. For a given MN, let the path from the RP to the MN contains  $L$  links on average. This is the path from the BR to the serving AR to the MN. Also, let  $n$  be the number of ARs other than the serving AR in the CAR-set. Hence, the CAR-set is  $\{AR_0, AR_1, \dots, AR_n\}$ , where  $AR_0$  is the serving AR. Furthermore, let  $L_i$  be the number of links leading from  $AR_i$  to the nearest point already branch from the RP to  $AR_0$ , where  $i=1,2,\dots,n$ . If we measure the overhead by the number of additional links traversed by the replicated packets, then the overhead is  $\sum L_i$ , called  $L_{sum}$ . The ratio  $L_{sum}/L$  gives the measure of additional links carrying replication traffic due to packet replication for a given MN connected to  $AR_0$ . The upper bound for the total replication traffic on the additional links for  $AR_0$  is  $m$ , where  $m$  is the number of MNs connected to  $AR_0$ .

The replication traffic on a link consumes link bandwidth proportional to  $k.b$ , where  $k$  is the number of ARs for which the link is an additional link carrying replication traffic and  $b$  is the wireless bandwidth for each AR. Typically wireless bandwidth is much smaller than the bandwidth of the wired links and it constrains the traffic (including the replication traffic) over the wired links.

We adopt a two-dimensional approach to reduce the replication traffic by limiting the size of the CAR-set (space-dimension) and the duration (time-dimension) for which the replication is performed in the network.

In this paper we presented a simple static CAR-set algorithm, however a more dynamic algorithms can be designed by identifying the highly probable new ARs. We are exploring this area further. For reducing the duration of replication traffic we are working on a heuristic that can potentially reduce the overhead significantly, as follows. When an access router (old AR) detects that the signal as seen by the MN is fading and is an indicative of handover condition, it then triggers the ARs in the CAR-set to join the multicast group. To avoid packet losses, the handover condition must be detected early enough to provide time margin before actual handover required for multicast join to happen. Once the MN is connected to the new AR, the CAR-set members leave the group. Thus, the overhead due to the replication traffic is reduced to only the fraction of the time during which the CAR-set remains joined to the multicast group, that is, only as long as the handover condition exists.

## 6. Related Work

Several architectures have been proposed to provide IP mobility support. In Mobile IP (MIP) [3], every mobile node (MN) is assigned a home address and home agent (HA) in its home subnet. When the MN moves to another foreign subnet, it acquires a care-of-address (COA) through a foreign agent (FA). The MN informs the HA of its COA through a registration process. Packets destined to the MN are sent first to the HA, then are tunneled to the MN. This is known as

triangle routing, a major drawback of MIP. Route optimization in [4] attempts to avoid triangle routing by sending binding updates, containing the current COA of the MN to the correspondent node (CN). However, communication overhead during handover renders this scheme unsuitable for micro mobility.

In [16] end-to-end IP mobility is proposed, based on dynamic DNS updates. When MN moves, it obtains a new IP-address and updates the DNS mapping for its host name. This incurs handover latency due to DNS update delays and is not suitable for delay-bounded applications. Also, the scheme is not transparent to transport protocols.

In [10] the HA tunnels packets using a pre-arranged multicast group address. The access router, to which the MN is currently connected, joins the group to get data packets over the multicast tree. This approach suffers from the triangle routing problem; packets are sent to HA first and then to MN. Multicast-based mobility is proposed in [1] and [8]. Each MN is assigned only a unique multicast address. Packets sent to the MN are destined to that multicast address and flow down the multicast distribution tree to the MN. The CN tunnels the packets using the multicast address. This approach avoids triangle routing, in addition to reducing handover latency and packet loss. The study in [1] quantifies the superiority of handover performance for multicast-based mobility over Mobile IP protocols. These schemes, however, suffer from several serious practical issues, including scalability of multicast state, address allocation and dependency on inter-domain multicast. We address these issues in our work.

Several approaches have been proposed for micro mobility [18]. The general approaches include mobile-specific routing, hierarchical approaches and seamless handover. Mobile-specific route approaches include cellular IP [20] and Hawaii [21]. A domain-gateway registers its address with the HA (this has similarities to our proxy-based approach) and forwards the packets to the MN. The MN's home address is used within the domain. These approaches need special signaling to update mobile-specific routes and require changes in packet forwarding and unicast routing in all the routers. In cellular IP [20], signaling is data-triggered to create paths by having routers snoop on the data packets. Hawaii [21] proposes a separate routing protocol and requires explicit signaling from the mobiles. In a way, these approaches attempt to create a distribution tree using extra routing entries for the mobile, similar to multicast. Our approach builds upon existing multicast mechanisms as opposed to re-creating them.

Approaches based on seamless handover between old and new access routers, involve fairly complex signaling, buffering and synchronization procedures. Router-assisted smooth handoff in MIP [5], and edge mobility [22] belong to this category. Fast Handover in [31] introduces fast tunnel set-up between  $AR_{old}$  and  $AR_{new}$  as soon as the layer 2

handoff is detected. The tunnel avoids packet losses caused by path set-up delay inside the mobility domain. In a way it is complementary to our multicast-based routing inside the mobility domain. Unlike fast handover, however, our m-subnet idea considers the edge of the network as a single subnet and allows mobile node to carry RCOA and MCOA across ARs, which reduces the handover latency. Approaches using a hierarchy employ a gateway per-domain and need to keep a location database to map identifiers into locations. This mapping suffers from scalability and robustness problems as was noted earlier in this paper. In [12] a hierarchy of foreign agents is created at the local, administrative domain and global levels. In [19] a multi-level hierarchy is used in which packets from the HA arrive at a root FA where they are tunneled to a lower level FA and then to the MN. Hierarchical MIP [27] builds a network of tunnels (overlay network) between FAs. Work in [23] and [29] also uses a notion of mobility agent for localized handoff within a domain. We have shown in [39] that our multicast-based intra-domain mobility scheme outperforms seamless handover and hierarchical approaches and is simpler. This result is consistent with the comparison of routing-based (HAWAII and CIP) and tunneling-based (Hierarchical Mobile IP) schemes reported in [40]. It is shown that Hierarchical Mobile IP performs either equally well or inferior to the routing-based schemes, because it does not take advantage of the proximity of crossover router to the serving AR. In addition, our comparison results for CIP and HAWAII are generally consistent with the above study. However, we have used more complex topologies, scenarios of reactive handoff, and we investigated performance in a more detailed manner; instead of looking at averages we looked at specific metrics as function of the hop distance from the old AR to the fork router and the new AR to the fork router. Our results indicate that M&M performance during proactive handover matches that of CIP and is better than Hawaii. For reactive handover we show that M&M clearly outperforms CIP and Hawaii.

## 7. Concluding Remarks

We have presented a novel approach to IP micro-mobility using intra-domain multicast-based mobility. Our approach solves major challenging problems facing the deployment of multicast-based mobility. In terms of multicast state scalability we note that the multicast state growth is  $O(G)$  for the architecture presented in this study, as opposed to  $O(S \times G)$  in [1][8]. Our novel algorithmic mapping scheme from unicast to multicast address ensures collision-free assignment by providing unique and consistent mapping throughout the network. This solves the address allocation problem and provides robustness and per-domain privacy as multicast packets are not forwarded out of the domain. In addition, we present a new proactive path setup scheme to improve handover performance. Our extensive simulations show that:

- There is a significant difference in handoff delay and packet reordering performance between protocols using different types of handoff schemes. For example, M&M and CIP use bi-cast while HAWAII use buffer and forwarding.
- In most cases M&M and CIP show comparable routing efficiency and handoff performance because both use shortest path routing as opposed to HAWAII. Routing packets on the path that is not the shortest path from the root of the tree to the MN not only increases end-to-end delay, but also wastes bandwidth and creates extra mobile specific routing entries.
- Bi casting:
  - Masks handoff delays (virtually zero delay)
  - Produces duplicate packets
  - Shows small reordering depth depending on the difference in the path lengths from the fork router to the old and new access routers
- Buffering and forwarding
  - Incurs longer handoff delays
  - May produce large reordering depth

For proactive handover M&M performs as well as CIP, and it handles the case of multiple BR in a domain better than others. The M&M scheme clearly outperforms CIP and HAWAII in reactive handover because of its proactive (CAR-set) path setup capability. It uses multicast routing protocol, e.g. PIM-SM, which is more reliable with readily available robust implementation and people having more experienced managing it. All these factors facilitate the deployment of M&M per ISP domain. Furthermore, M&M naturally supports efficient multicasting to MNs.

In the future, we plan to conduct further simulations to evaluate a richer set of reactive handover scenarios. In addition, we plan to further pursue our approaches to reduce overhead of the CAR-set algorithm and conduct a detailed study of such overhead. We also would like to investigate M&M's support for efficient mobile-to-mobile communication.

## 8. References

- [1] A. Helmy, "A Multicast-based Protocol for IP Mobility Support", ACM SIGCOMM Second International Workshop on Networked Group Communication (NGC 2000), Palo Alto, November 2000.
- [2] D. Estrin, D. Farinacci, A. Helmy, D. Thaler, S. Deering, V. Jacobson, M. Handley, C. Liu, P. Sharma, "Protocol Independent Multicast – Sparse Mode (PIM-SM): Protocol Specification", *RFC 2362/2117 of the IETF*, March '97/'98.
- [3] C. Perkins, "IP Mobility Support", *RFC 2002, Internet Engineering Task Force*, October 1996.
- [4] C. Perkins, D. Johnson, "Route Optimization in Mobile IP", *Internet Draft, Internet Engineering Task Force*, February 2000.
- [5] C. Perkins and D. Johnson, "Mobility Support in IPv6", *Proceedings of MobiCom '96*, November 1996.
- [6] D. Johnson, C. Perkins, "Mobility Support in IPv6", *Internet Draft, Internet Engineering Task Force*, March 2000.
- [7] A. Myles, D. Johnson, C. Perkins, "A Mobile Host Protocol Supporting Route Optimization and Authentication", *IEEE Journal on Selected Areas in Communications*, vol. 13, No. 5, p. 839-849, June 1995.
- [8] J. Mysore, V. Bharghavan, "A New Multicasting-based Architecture for Internet Host Mobility", *Proceedings of ACM MobiCom*, September 1997.
- [9] J. Mysore, V. Bharghavan, "Performance of Transport Protocols over a Multicasting-based Architecture for Internet Host Mobility", *International Conference on Communications (ICC) '98*, vol. 3, p. 1817-1823, 1998.
- [10] S. Seshan, H. Balakrishnan, R. Katz, "Handovers in Cellular Wireless Networks: The Daedalus Implementation and Experience", *Kluwer Journal on Wireless Networks*, 1995.
- [11] H. Balakrishnan, S. Seshan, R. Katz, "Improving Reliable Transport and Handover Performance in Cellular Wireless Networks", *Proceedings of ACM MobiCom '95*, November 1995.
- [12] R. Caceres, V. Padmanabhan, "Fast and Scalable Handovers for Wireless Internetworks", *Proceedings of ACM MobiCom '96*, November 1996.
- [13] R. Caceres, V. Padmanabhan, "Fast and Scalable Wireless Handovers in Support of Mobile Internet Audio", *ACM Journal on Mobile Networks and Applications*, vol. 3, No. 4, December 1998.
- [14] A. Acampora, M. Naghshineh, "An Architecture and Methodology for Mobile-Executed Handover in Cellular ATM", *IEEE Journal on Selected Areas in Communications*, vol. 12, No. 8, p. 1365-1375, October 1994.
- [15] S. Kumar, P. Radoslavov, D. Thaler, C. Alaettinoglu, D. Estrin, M. Handley, "The MASC/BGMP Architecture for Inter-domain Multicast Routing", *Proceedings of ACM SIGCOMM*, August 1998.
- [16] A. Snoeren, H. Balakrishnan, "An End-to-End Approach to Host Mobility", *Accepted to ACM MobiCom '00*, August 2000.
- [17] L. Breslau, D. Estrin, K. Fall, S. Floyd, J. Heidemann, A. Helmy, P. Huang, S. McCanne, K. Varadhan, Y. Xu, H. Yu, "Advances in Network Simulation", *IEEE Computer*, vol. 33, No. 5, p. 59-67, May 2000.
- [18] A. T. Campbell and J. Gomez IP Micro-Mobility Protocols, ACM SIGMOBILE Mobile Computer and Communication Review (MC2R), 2001
- [19] E. Gustafsson, A. Jonsson, C. Perkins, Mobile IP Regional Registration, Internet-draft, draft-ietf-mobileip-reg-tunnel-02, March 2000.
- [20] A. Campbell, J. Gomez, S. Kim, A. Valko, C. Wan, Z. Turanyi, "Design, implementation, and evaluation of cellular

- IP" IEEE Personal Communications , Volume: 7 Issue: 4 , Page(s): 42–49, Aug. 2000.
- [21] R. Ramjee, T. La Porta, L. Salgarelli, S. Thuel, K. Varadhan, L. Li, "IP-based access network infrastructure for next-generation wireless data networks", IEEE Personal Communications, Volume: 7 Issue: 4, Page(s): 34–41, Aug. 2000.
- [22] A. O'Neill, G. Tsirtsis, S. Corson, Edge Mobility Architecture, Internet-draft, draft-oneill-ema-02.txt, July 2000.
- [23] J. Kempf, P. Calhoun, C. Pairla, Foreign Agent Assisted Handover, Internet-draft, draft-calhoun-mobileip-proactive-fa-01.txt, June 2000.
- [24] D. Estrin, M. Handley, A. Helmy, P. Huang, D. Thaler, "A Dynamic Bootstrap Mechanism for Rendezvous-based Multicast Routing", Proceedings of IEEE INFOCOM '99, New York, March 1999.
- [25] S. Deering, D. Cheriton, "Multicast routing in data internetworks and extended lans", ACM Transactions on Computer Systems, pp 85-111, May 1990.
- [26] E. Fleury, Yih Huang, P.K. McKinley. "On the performance and feasibility of multicast core selection heuristics", 7th International Conference on Computer Communications and Networks, Page(s): 296–303, 1998.
- [27] H. Soliman, C. Castelluccia, K. Elmalki, L. Bellier, "Hierarchical Mobile IPv6", Internet Draft, draft-ietf-mobileip-hmipv6-04.txt, July 2001.
- [28] A. Misra, S. Das, A. Mcauley, A. Dutta, S. K. Das, "IDMP: An Intra-Domain Mobility Management Protocol using Mobility Agents", I-Draft, draft-misra-mobileip-idmp-00.txt, Jan 2000.
- [29] G. Dommety, "Local and Indirect Registration for Anchoring Handoffs", I-Draft, draft-dommety-mobileip-anchor-handoff-01.txt, December 2000.
- [30] K. Calvert, M. Doar, E. Zegura, "Modeling Internet Topology", *IEEE Comm*, p. 160-163, June 1997.
- [31] G. Dommety, et al, "Fast Handovers for Mobile IPv6", Internet Draft, draft-ietf-mobileip-fast-mipv6-02.txt, July 2001.
- [32] R. Hinden, S. Deering, "IP Version 6 Addressing Architecture", Internet Draft, draft-ietf-ipngwg-addr-arch-v3-06.txt, July 2001.
- [33] R. Hinden, M. O'Dell, S. Deering, "An IPv6 Aggregatable Global Unicast Address Format", RFC 2374, July 1998.
- [34] J. Bound, et al, "Dynamic Host Configuration Protocol for IPv6 (DHCPv6)", Internet Draft, draft-ietf-dhc-dhcpv6-19.txt, June 2001.
- [35] S. Thomson, T. Narten, "IPv6 Stateless Address Autoconfiguration", RFC 2462, December 1998.
- [36] 3GPP, "3GPP TS Group Core Network; Numbering, addressing, and identification", 3GPP TS 23.003 V5.0.0 (2001-06), www.3gpp.org, June 2001.
- [37] T. Narten, E. Normark, W. Simpson, "Neighbor Discovery for IP Version 6 (IPv6)", RFC 2461, December 1998.
- [38] A. Helmy, "State Analysis and Aggregation Study for Multicast-based Micro Mobility", IEEE International Conference on Communications (ICC), May 2002.
- [39] A. Helmy, and M. Jaseemuddin, "Efficient Micro-Mobility using Intra-domain Multicast-based Mechanisms (M&M)", *USC-CS-TR-01-747*, Aug 2001.
- [40] A. Campbell, J. Gomez, S. Kim, Z. Turanyi, C-Y Wan, A. Valko, "Comparison of IP Micromobility Protocols", IEEE Wireless Communications, Vol. 9, No. 1, pp. 72-82, February 2002.
- [41] Hongyi Li, "A Micro-Mobility Routing Protocol for Wireless Internet", IP-Based Cellular Networks (IPCN) 2001, May 17, 2001, Paris, France.